

# Predelivery Instructions

1625  
Yield Pro Planter

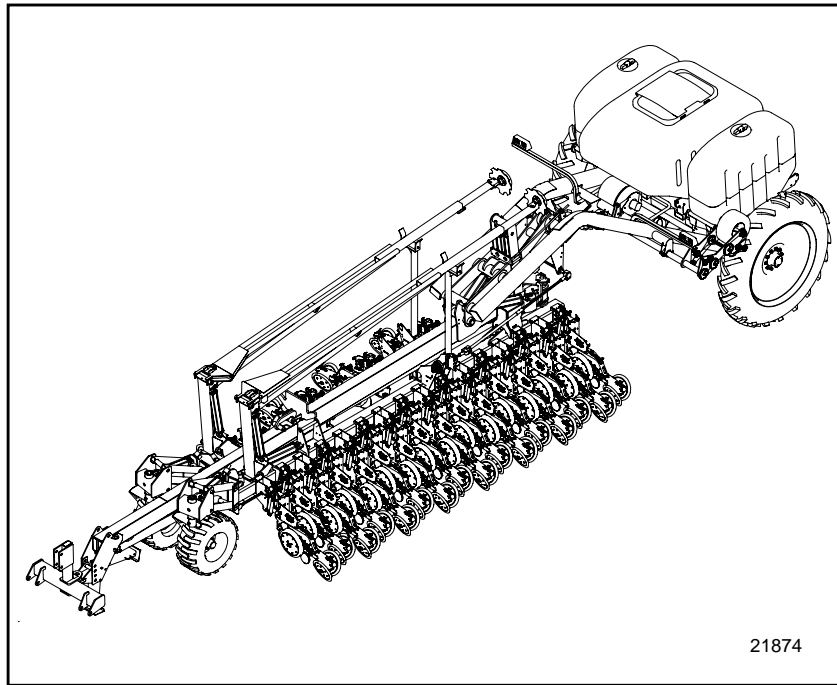

*Read the operator's manual entirely. When you see this symbol, the subsequent instructions and warnings are serious - follow without exception. Your life and the lives of others depend on it!*



*Cover illustration may show optional equipment not supplied with standard unit.*



# Table of Contents

<b>Important Safety Information</b> .....	<b>1</b>
Wear Protective Equipment .....	5
Handle Chemicals Properly .....	6
<b>Introduction</b> .....	<b>8</b>
Description of Unit .....	8
Intended Usage .....	8
Using This Manual .....	8
Definitions .....	8
<b>Adjustments Before Going to the Field</b> .....	<b>9</b>
General Maintenance .....	9
General Information .....	9
Initial Planter Leveling .....	9
Initial Planter Setting .....	10
Initial Metering System Setting .....	10
Field adjustments and General Operating Instructions .....	10
Seed and the Use of Inoculants and Treatments .....	11
Finger-Pickup Meters .....	11
Precision Meters .....	11
<b>Appendix</b> .....	<b>12</b>
Torque Values Chart .....	12
Tire Inflation Chart .....	12
Hydraulic Schematic .....	13

© Copyright 2004 All rights Reserved

Great Plains Manufacturing, Inc. provides this publication "as is" without warranty of any kind, either expressed or implied. While every precaution has been taken in the preparation of this manual, Great Plains Manufacturing, Inc. assumes no responsibility for errors or omissions. Neither is any liability assumed for damages resulting from the use of the information contained herein. Great Plains Manufacturing, Inc. reserves the right to revise and improve its products as it sees fit. This publication describes the state of this product at the time of its publication, and may not reflect the product in the future.

Great Plains Manufacturing, Incorporated Trademarks

The following are trademarks of Great Plains Mfg., Inc.: Application Systems, Ausherman, Land Pride, Great Plains

All other brands and product names are trademarks or registered trademarks of their respective holders.

*Printed in the United States of America.*



## Important Safety Information

### Look for Safety Symbol

The SAFETY ALERT SYMBOL indicates there is a potential hazard to personal safety involved and extra safety precaution must be taken. When you see this symbol, be alert and carefully read the message that follows it. In addition to design and configuration of equipment, hazard control and accident prevention are dependent upon the awareness, concern, prudence and proper training of personnel involved in the operation, transport, maintenance and storage of equipment.



### Be Aware of Signal Words

Signal words designate a degree or level of hazard seriousness.

**DANGER** indicates an imminently hazardous situation which, if not avoided, will result in death or serious injury. This signal word is limited to the most extreme situations, typically for machine components that, for functional purposes, cannot be guarded.



**WARNING** indicates a potentially hazardous situation which, if not avoided, could result in death or serious injury, and includes hazards that are exposed when guards are removed. It may also be used to alert against unsafe practices.



**CAUTION** indicates a potentially hazardous situation which, if not avoided, may result in minor or moderate injury. It may also be used to alert against unsafe practices.



## Be Familiar with Safety Decals

- ▲ Read and understand "Safety Decals," page 8 in the operator's manual, thoroughly.
- ▲ Read all instructions noted on the decals.

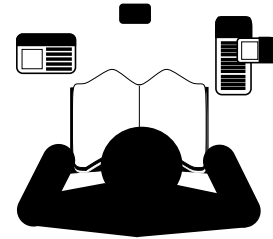

## Keep Riders Off Machinery

Riders obstruct the operator's view. Riders could be struck by foreign objects or thrown from the machine.

- ▲ Never allow children to operate equipment.
- ▲ Keep all bystanders away from machine during operation.

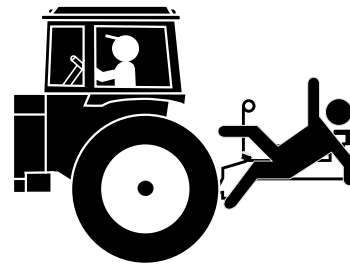

## Shutdown and Storage

- ▲ Lower planter, put tractor in park, turn off engine, and remove the key.
- ▲ Secure planter using blocks and supports provided.
- ▲ Detach and store planter in an area where children normally do not play.

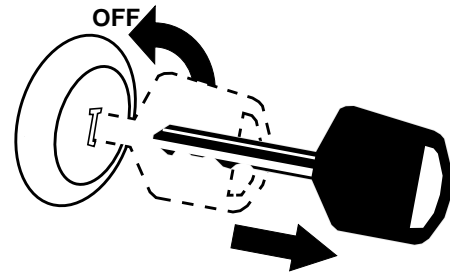

## Use Safety Lights and Devices

Slow-moving tractors and towed implements can create a hazard when driven on public roads. They are difficult to see, especially at night.

- ▲ Use flashing warning lights and turn signals whenever driving on public roads.
- ▲ Use lights and devices provided with implement.

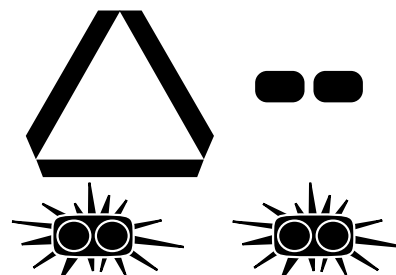

## Transport Machinery Safely

Maximum transport speed for implement is 20 mph. Some rough terrains require a slower speed. Sudden braking can cause a towed load to swerve and upset.

- ▲ Do not exceed 20 mph. Never travel at a speed which does not allow adequate control of steering and stopping. Reduce speed if towed load is not equipped with brakes.
- ▲ Comply with state and local laws.
- ▲ Do not tow an implement that, when fully loaded, weighs more than 1.5 times the weight of towing vehicle.
- ▲ Carry reflectors or flags to mark planter in case of breakdown on the road.
- ▲ Keep clear of overhead power lines and other obstructions when transporting.
- ▲ Do not fold or unfold the planter while the tractor is moving.

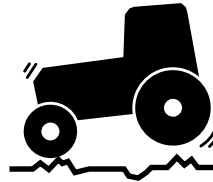
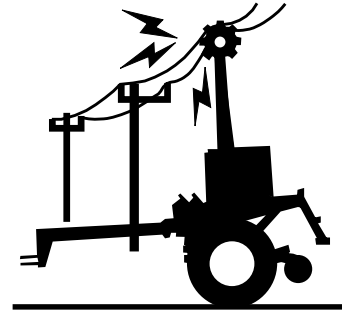

## Avoid High Pressure Fluids

Escaping fluid under pressure can penetrate the skin, causing serious injury.

- ▲ Avoid the hazard by relieving pressure before disconnecting hydraulic lines.
- ▲ Use a piece of paper or cardboard, NOT BODY PARTS, to check for suspected leaks.
- ▲ Wear protective gloves and safety glasses or goggles when working with hydraulic systems.
- ▲ If an accident occurs, see a doctor immediately. Any fluid injected into the skin must be surgically removed within a few hours or gangrene may result.

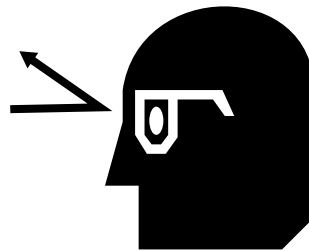

## Prepare for Emergencies

- ▲ Be prepared if a fire starts.
- ▲ Keep a first aid kit and fire extinguisher handy.
- ▲ Keep emergency numbers for doctor, ambulance, hospital and fire department near phone.

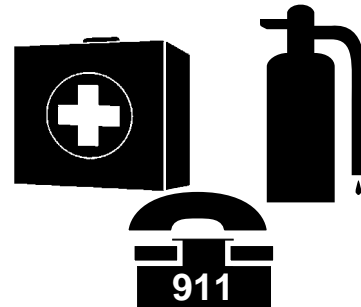

## Practice Safe Maintenance

- ▲ Understand procedure before doing work. Use proper tools and equipment. Refer to this manual for additional information.
- ▲ Work in a clean, dry area.
- ▲ Lower the planter, put tractor in park, turn off engine, and remove key before performing maintenance.
- ▲ Make sure all moving parts have stopped and all system pressure is relieved.
- ▲ Allow planter to cool completely.
- ▲ Disconnect battery ground cable (-) before servicing or adjusting electrical systems or before welding on planter.
- ▲ Inspect all parts. Make sure parts are in good condition and installed properly.
- ▲ Remove buildup of grease, oil or debris.
- ▲ Remove all tools and unused parts from planter before operation.

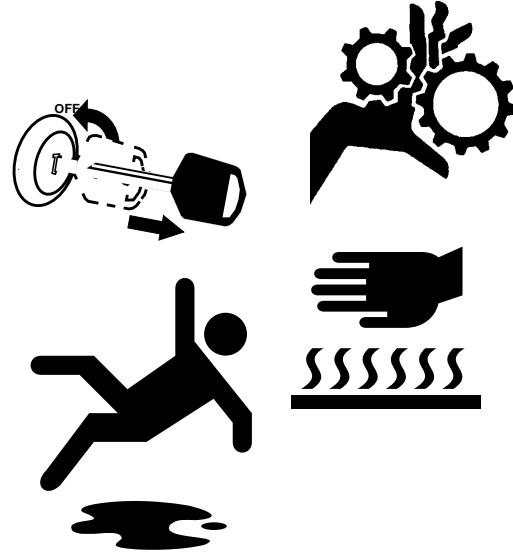

## Use A Safety Chain

- ▲ Use a safety chain to help control drawn machinery should it separate from tractor drawbar.
- ▲ Use a chain with a strength rating equal to or greater than the gross weight of towed machinery.
- ▲ Attach chain to tractor drawbar support or other specified anchor location. Allow only enough slack in chain to permit turning.
- ▲ Replace chain if any links or end fittings are broken, stretched or damaged.
- ▲ Do not use safety chain for towing.

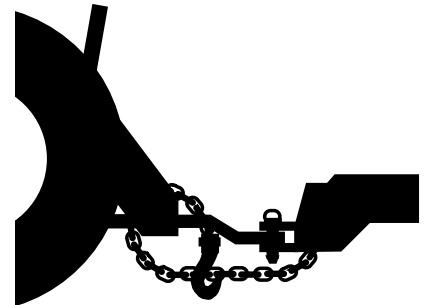
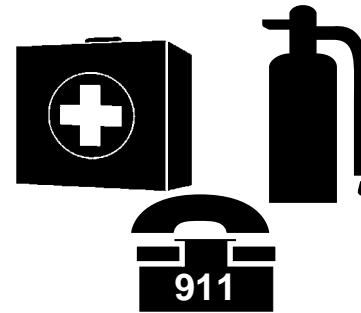

## Tire Safety

Tire changing can be dangerous and should be performed by trained personnel using correct tools and equipment.

- ▲ When inflating tires, use a clip-on chuck and extension hose long enough for you to stand to one side—not in front of or over tire assembly. Use a safety cage if available.
- ▲ When removing and installing wheels, use wheel-handling equipment adequate for weight involved.



## Wear Protective Equipment

Great Plains advises all users of chemical pesticides or herbicides to use the following personal safety equipment.

- ▲ Waterproof, wide-brimmed hat
- ▲ Waterproof apron.
- ▲ Face shield, goggles or full face respirator.
- ▲ Goggles with side shields or a full face respirator is required if handling or applying dusts, wettable powders, or granules or if being exposed to spray mist.
- ▲ Cartridge-type respirator approved for pesticide vapors unless label specifies another type of respirator.
- ▲ Waterproof, unlined gloves. Neoprene gloves are recommended.
- ▲ Cloth coveralls/outer clothing changed daily; waterproof items if there is a chance of becoming wet with spray
- ▲ Waterproof boots or foot coverings
- ▲ Do not wear contaminated clothing. Wash protective clothing and equipment with soap and water after each use. Personal clothing must be laundered separately from household articles.
- ▲ Clothing contaminated with certain pesticides must be destroyed according to state and local regulations. Read chemical label for specific instructions.
- ▲ Wear clothing and equipment appropriate for the job. Avoid loose-fitting clothing.
- ▲ Prolonged exposure to loud noise can cause hearing impairment or loss. Wear suitable hearing protection such as earmuffs or earplugs.
- ▲ Avoid wearing radio headphones while operating machinery. Operating equipment safely requires the full attention of the operator.

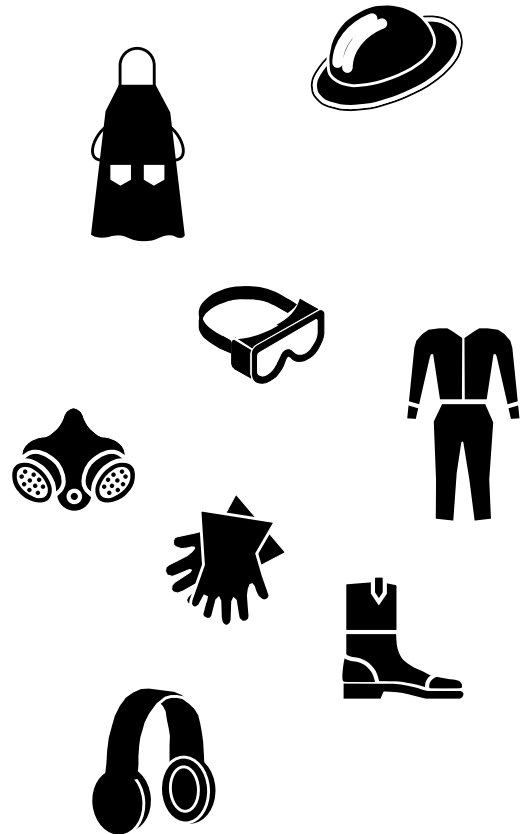

## Handle Chemicals Properly

- ▲ Read and follow chemical manufacturer's instructions.
- ▲ Wear protective clothing.
- ▲ Handle all chemicals with care.
- ▲ Agricultural chemicals can be dangerous. Improper use can seriously injure persons, animals, plants, soil and property.
- ▲ Inhaling smoke from any type of chemical fire is a serious health hazard.
- ▲ Store or dispose of unused chemicals as specified by the chemical manufacturer.
- ▲ Before adding chemical to the tank, make sure tank is at least half full. Do not pour concentrate into an empty tank.
- ▲ Never leave fill hose attached to the sprayer after filling tank. Chemicals in tank can siphon out of tank and contaminate freshwater source.
- ▲ Always keep hand-wash tank filled with clean water and have soap available in case of an emergency. Immediately and thoroughly flush any area of the body that is contaminated by chemicals.
- ▲ Do not touch sprayer components with mouth or lips.
- ▲ If chemical is swallowed, carefully follow the chemical manufacturer's recommendations and consult with a doctor.
- ▲ If persons are exposed to a chemical in a way that could affect their health, consult a doctor immediately with the chemical label or container in hand. Any delay could cause serious illness or death.
- ▲ Dispose of empty chemical containers properly. By law rinsing of the used chemical container must be repeated three times. Puncture the container to prevent future use. An alternative is to jet-rinse or pressure rinse the container.
- ▲ Wash hands and face before eating after working with chemicals. Shower as soon as spraying is completed for the day.

- ▲ Spray only with acceptable wind conditions. Wind speed must be below 5 mph. Make sure wind drift of chemicals will not affect any surrounding land, people or animals.
- ▲ Never wash out the sprayer tank within 100 feet of any freshwater source or in a car wash.
- ▲ Rinse out the tank. Spray rinse water on last field sprayed.





## Safety At All Times

Thoroughly read and understand the instructions in this manual before operation. Read all instructions noted on the safety decals.

- ▲ Be familiar with all planter functions.
- ▲ Operate machinery from the driver's seat only.
- ▲ Do not leave planter unattended with tractor engine running.
- ▲ Do not dismount a moving tractor. Dismounting a moving tractor could cause serious injury or death.
- ▲ Do not stand between the tractor and planter during hitching.
- ▲ Keep hands, feet and clothing away from power-driven parts.
- ▲ Wear snug-fitting clothing to avoid entanglement with moving parts.
- ▲ Watch out for wires, trees, etc., when folding and raising planter. Make sure all persons are clear of working area.
- ▲ Do not turn tractor too tightly, causing planter to ride up on wheels. This could cause personal injury or equipment damage.

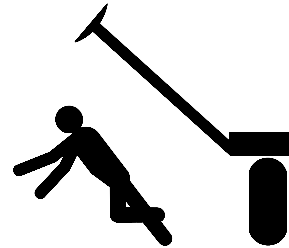
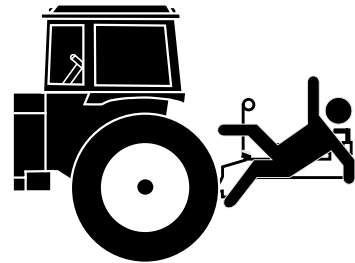
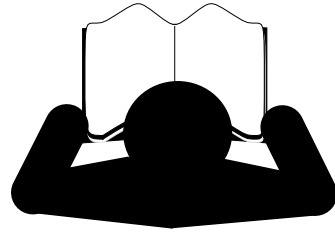



## Introduction

### Description of Unit

The 1625 Yield Pro Planter is a pull-type seeding implement for use in conventional till, minimum-till or light no-till conditions. The 1625 Yield Pro Planter can be outfitted with optional unit mounted coulters. The unit mounted coulters do not make it suitable for heavy no-till conditions. The 1625 Yield Pro Planter is outfitted with 25 series, side-depth-control row-units. The 1625 Yield Pro Planter folds for transport.

### Intended Usage

Use the planter to seed production-agriculture crops only. Do not modify the planter for use with attachments other than Great Plains options and accessories specified for use with the planter.

### Using This Manual

This manual will familiarize you with safety, assembly, operation, adjustments, troubleshooting and maintenance. Read this manual and follow the recommendations to help ensure safe and efficient operation.

The information in this manual is current at printing. Some parts may change to assure top performance.

### Definitions

The following terms are used throughout this manual.

Right-hand and left-hand as used in this manual are determined by facing the direction the machine will travel while in use unless otherwise stated.

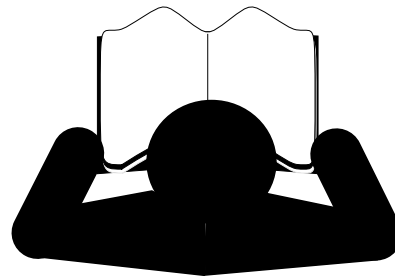

---

**IMPORTANT:** A crucial point of information related to the preceding topic. For safe and correct operation, read and follow the directions provided before continuing.

---

**NOTE:** Useful information related to the preceding topic.



# Adjustments Before Going to the Field

## General Maintenance

1. Refer to the operator's manual for proper lubrication intervals and maintenance schedules. Be sure to lubricate all grease fittings, especially the wing drive shafts.
2. Inspect the tire pressure of all tires.
  - a. Contact drive tires: 12 to 15 psi
  - b. Rear transport tires:
    - 14.9 x 46 8-star (for planters with fertilizer tanks and 82 bu. hopper): 60 psi
    - 14.9 x 46 8-star (for planters without fertilizer tanks and 82 bu. hopper): 30 psi
  - c. End transport 395/33B 16.5 NHS Skid Steer tire: 60 psi

NOTE: The pressure of the contact drive wheel is especially important. Deviating from the proper setting will affect the seeding rate.

## General Information

1. Be certain all 3-point hitch latches are properly fastened and all safety lighting is properly installed and functioning correctly.

## Initial Planter Leveling

1. Unfold the unit on a level site.
2. Set the 3-point hitch so the top of the tongue is 46" off the ground. Set the 3-point down stop so you can reference this setting when moving from field to field. When setting hitch at 46", lower lift cylinders completely, then adjust.

---

Important: Planter must be fully lowered to field position and hitch height must be set before making end-to-end adjustments.

---

3. Locate the threaded eye bolt at the base end of the gauge-wheel cylinders. The eye bolt is locked in place by a jam nut. Observe the distance between the eye and mounting base. This should measure 2 1/2", if so, no initial adjustment is needed.
4. If the distance between the eye and mounting base does not measure 2 1/2", loosen and adjust the jam nuts until it does. Repeat for other end of planter.

5. Move the planter to a level area. With the planter unfolded, raise the planter to its highest position with the lift cylinders. With the tractor idling, rephase the cylinders by holding the hydraulic lever on for an additional 30 seconds. Immediately lower the planter until the row-units are just ready to touch the ground.
6. Move the gauge-wheel eye bolts until the row-units on the outside end of the planter are the same height as the center row-units.

NOTE: Eye-bolt adjustments are easier if the planter is first lowered to the ground to remove some of the force on the cylinders.

7. Repeat the steps above until the planter is level end-to-end when planting in actual seeding conditions.
8. With the planter unfolded and lowered in the field position, place a block ahead of the wing gauge wheels and pull ahead slightly to tension the pull bars. The ends of the wing should be even to 1/4" forward of the center.
9. Lower unit fully, pull ahead a short distance and check the parallel arms on the row-units. They should be horizontal or slightly lower in the rear. Row-units should also be horizontal with the ground.
10. Before making any adjustments be sure row-units are at the proper planting depth. Raising or lowering the 3-point hitch slightly will help level the openers for front-to-rear.
11. The planter lift cylinders may be equipped with depth control collars if needed to adjust the levelness of the parallel arms.
12. Re-check the end-to-end levelness and re-adjust the eye bolts if needed.
13. The desired orientation is to have the row-units level from front-to-rear, the parallel arms level from front-to-rear or slightly low in the rear, and the wing frames level from end-to-end so all row-units are the same.

## Initial Planter Setting

1. Adjust the unit mount coulters to the same depth as the opener discs.
2. Adjust the Terra-Tines as outlined in the operator's manual.
3. Adjust the opener down pressure to the correct initial setting.
  - a. Standard planter with no unit mount attachments planting into conventional tillage: 1st notch (lightest setting).
  - b. Standard planter with trash wheels in conventional to minimum tillage: 2nd from lightest setting.
  - c. Standard planter equipped with a unit mount coulters planting in no-till conditions: 2nd notch from lightest setting.
4. Set the opener depth so 7 holes are showing above the T-handles (this is approximately 1 3/4" of seed depth).
5. Raise the side depth arm. If adjusted correctly, it should contact the row-unit disks at the bottom of wheel at 2" planting depth, but drop fully when released. (For adjustment instructions refer to "Side Gauge Wheels," page 37 in the operator's manual.
6. Place the closing wheel pressure handle in the lightest setting (the first position from the front).

NOTE: These are initial settings and may be adjusted as needed.



### CAUTION

*Always start at the lowest possible opener down pressure spring setting. This is important because as the pressure is increased, it can have a negative impact on the overall flexibility of the planter. Do not use any setting which appears to raise the wing frame.*

## Initial Metering System Setting

1. Fan starting range: 3800 to 4200 R.P.M.
2. Finger pick-up brush setting: Refer to "Brush," page 46 in the operator's manual for proper adjustment.
3. Singulator Plus meter: Refer to "Seed Rate Charts," page 76 in the operator's manual, and install the correct meter wheel.

4. Setting the seed rate:
  - a. For contact drive equipped units, refer to "Seed Rate Charts," page 76 in the operator's manual, and select the correct range and transmission settings.
  - b. For Veris drive equipped units, refer to "Veris Drive Operating Instructions," page 72 in the operator's manual, and select the correct calibration number and set the controller to the correct population.
5. Refer to "Fertilizer Rate Charts," page 51 in the operator's manual, and select the correct fertilizer rate.

NOTE: An adjustment in the seeding rate will affect the fertilizer rate.

6. Refer to "Orifice Size Charts," page 53 in the operator's manual, and select the correct orifice to be placed in each wet boom manifold opening being used. The acceptable manifold operating pressure range is 5 to 65 psi. The preferred manifold operating range pressure is 15 to 40 psi.

NOTE: Remember, increasing or decreasing the number of rows used will affect the manifold pressure.

7. Set the marker length. Measure from the end of the inner marker adjustment tube to the end of the outer adjustment tube. The bench setting is:
  - 15" row spacing = 10 1/2" (adjust as needed)
  - 20" row spacing = 25 1/2" (adjust as needed)
  - 30" & TR spacing = 25 1/2" (adjust as needed)

NOTE: If a twin row planter is used on 30" single row spacing the right and left markers will be different lengths. Refer to "Marker Width," page 48 in the operator's manual, for the proper procedure to set the markers.

## Field adjustments and General Operating Instructions

1. Unfold the planter. Refer to "Unfolding the Planter," page 22 in the operator's manual.
2. Fill the seed and fertilizer tanks 1/2 full.
3. If some of the openers are to be locked-up in the storage position, do so at this time. Refer to "Row-Unit Lock-Up," page 38 in the operator's manual.

4. Turn off the air flow to the unused meters. **Do Not** remove the unused meters. **Do** disengage the meter drive at unused meters.
  5. Turn off the fertilizer to the unused rows. (Remember to re-check the manifold pressure as it will change.)
  6. Lower the planter and 3-point hitch to field position. (Make sure tongue height is 46" above the ground.)
  7. Tie up one row of closing wheels to inspect the actual depth of the seed.
  8. Pull ahead at field speed to inspect:
    - a. The levelness of the tongue and mainframe toolbars (front-to-back).
    - b. The levelness of toolbars (side-to-side).
    - c. Levelness of the parallel openers links.
    - d. Depth of seed.
    - e. Spacing of seed.
    - f. Side-to-side alignment of all the closing wheels.
    - g. Closing wheel spacing:
      - They can be adjusted in or out by moving the spacers. Refer to "Press Wheels," page 31 in the operator's manual.
      - If plugging between the closing wheels occurs, the closing wheels can also be staggered. Refer to "Press Wheels," page 31 in the operator's manual.
    - h. Closing wheel pressure.
    - i. Starter fertilizer manifold psi.
    - j. Seed distribution to the meters.
    - k. Measure the length of the marker and adjust if needed:
      - The angle of the marker can be increased to make the marker more aggressive.
      - Always pull the dirt in toward the planter, never push the dirt away.
2. Recommended usage:
    - a. For finger-pickup meters, add one teaspoon of graphite for each 4 units of seed corn (320,000 kernels).
    - b. In high humidity conditions or if you are using seed box seed treatments, or seed corn treated with any insecticides or polymers (Poncho, Prescribe, Cruiser, etc.), add one teaspoon of graphite for each unit of seed corn (80,000 kernel).
- NOTE: The use of talc is PROHIBITED in finger-pickup meters.
- Precision Meters**
1. Talc lubricant is mandatory for all seeds, especially treated or inoculated seed. Recommended usage:
    - a. For clean seeds, sprinkle one cup of talc per 3 bushels of seed.
    - b. For seed with excessive treatment, or for humid planting environments, double or triple talc rate as needed.
- NOTE: For Milo Planting Only. Powder graphite must be mixed with the milo seed in combination with talc for proper seed singulation. Recommended usage:
- Sprinkle one cup of graphite per 9 bushels of seed.
- NOTE: Do Not use liquid inoculants or seed treatments of any kind in this planter.



## Seed and the Use of Inoculants and Treatments



### Finger-Pickup Meters

1. Use only approved graphite powder available from Great Plains (EZ-Slide) to ensure proper lubrication of finger-pickup corn seed meters.

# Appendix

## Torque Values Chart

Bolt Size (Inches)	Bolt Head Identification					
						
	Grade 2		Grade 5		Grade 8	
in-tpi <sup>1</sup>	N · m <sup>2</sup>	ft-lb <sup>3</sup>	N · m	ft-lb	N · m	ft-lb
1/4" - 20	7.4	5.6	11	8	16	12
1/4" - 28	8.5	6	13	10	18	14
5/16" - 18	15	11	24	17	33	25
5/16" - 24	17	13	26	19	37	27
3/8" - 16	27	20	42	31	59	44
3/8" - 24	31	22	47	35	67	49
7/16" - 14	43	32	67	49	95	70
7/16" - 20	49	36	75	55	105	78
1/2" - 13	66	49	105	76	145	105
1/2" - 20	75	55	115	85	165	120
9/16" - 12	95	70	150	110	210	155
9/16" - 18	105	79	165	120	235	170
5/8" - 11	130	97	205	150	285	210
5/8" - 18	150	110	230	170	325	240
3/4" - 10	235	170	360	265	510	375
3/4" - 16	260	190	405	295	570	420
7/8" - 9	225	165	585	430	820	605
7/8" - 14	250	185	640	475	905	670
1" - 8	340	250	875	645	1230	910
1" - 12	370	275	955	705	1350	995
1-1/8" - 7	480	355	1080	795	1750	1290
1 1/8" - 12	540	395	1210	890	1960	1440
1 1/4" - 7	680	500	1520	1120	2460	1820
1 1/4" - 12	750	555	1680	1240	2730	2010
1 3/8" - 6	890	655	1990	1470	3230	2380
1 3/8" - 12	1010	745	2270	1670	3680	2710
1 1/2" - 6	1180	870	2640	1950	4290	3160
1 1/2" - 12	1330	980	2970	2190	4820	3560

Bolt Size (Metric)	Bolt Head Identification					
						
	Class 5.8		Class 8.8		Class 10.9	
mm x pitch <sup>4</sup>	N · m	ft-lb	N · m	ft-lb	N · m	ft-lb
M 5 X 0.8	4	3	6	5	9	7
M 6 X 1	7	5	11	8	15	11
M 8 X 1.25	17	12	26	19	36	27
M 8 X 1	18	13	28	21	39	29
M10 X 1.5	33	24	52	39	72	53
M10 X 0.75	39	29	61	45	85	62
M12 X 1.75	58	42	91	67	125	93
M12 X 1.5	60	44	95	70	130	97
M12 X 1	90	66	105	77	145	105
M14 X 2	92	68	145	105	200	150
M14 X 1.5	99	73	155	115	215	160
M16 X 2	145	105	225	165	315	230
M16 X 1.5	155	115	240	180	335	245
M18 X 2.5	195	145	310	230	405	300
M18 X 1.5	220	165	350	260	485	355
M20 X 2.5	280	205	440	325	610	450
M20 X 1.5	310	230	650	480	900	665
M24 X 3	480	355	760	560	1050	780
M24 X 2	525	390	830	610	1150	845
M30 X 3.5	960	705	1510	1120	2100	1550
M30 X 2	1060	785	1680	1240	2320	1710
M36 X 3.5	1730	1270	2650	1950	3660	2700
M36 X 2	1880	1380	2960	2190	4100	3220

<sup>1</sup> in-tpi = nominal thread diameter in inches-threads per inch

<sup>2</sup> N · m = newton-meters

<sup>3</sup> ft-lb= foot pounds

<sup>4</sup> mm x pitch = nominal thread diameter in millimeters x thread pitch

Torque tolerance + 0%, -15% of torquing values. Unless otherwise specified use torque values listed above.

## Tire Inflation Chart

Tire Size	Inflation PSI
395/55B 16.5 NHS Skid Steer	60
14.9 x 46 8 Star-Planters with fert. tanks and bean hopper	60
14.9 x 46 8 Star-Planters without fert. tanks and bean hopper	30
18 x 9.50-8 NHS (contact drive tire)	15

### Hydraulic Schematic

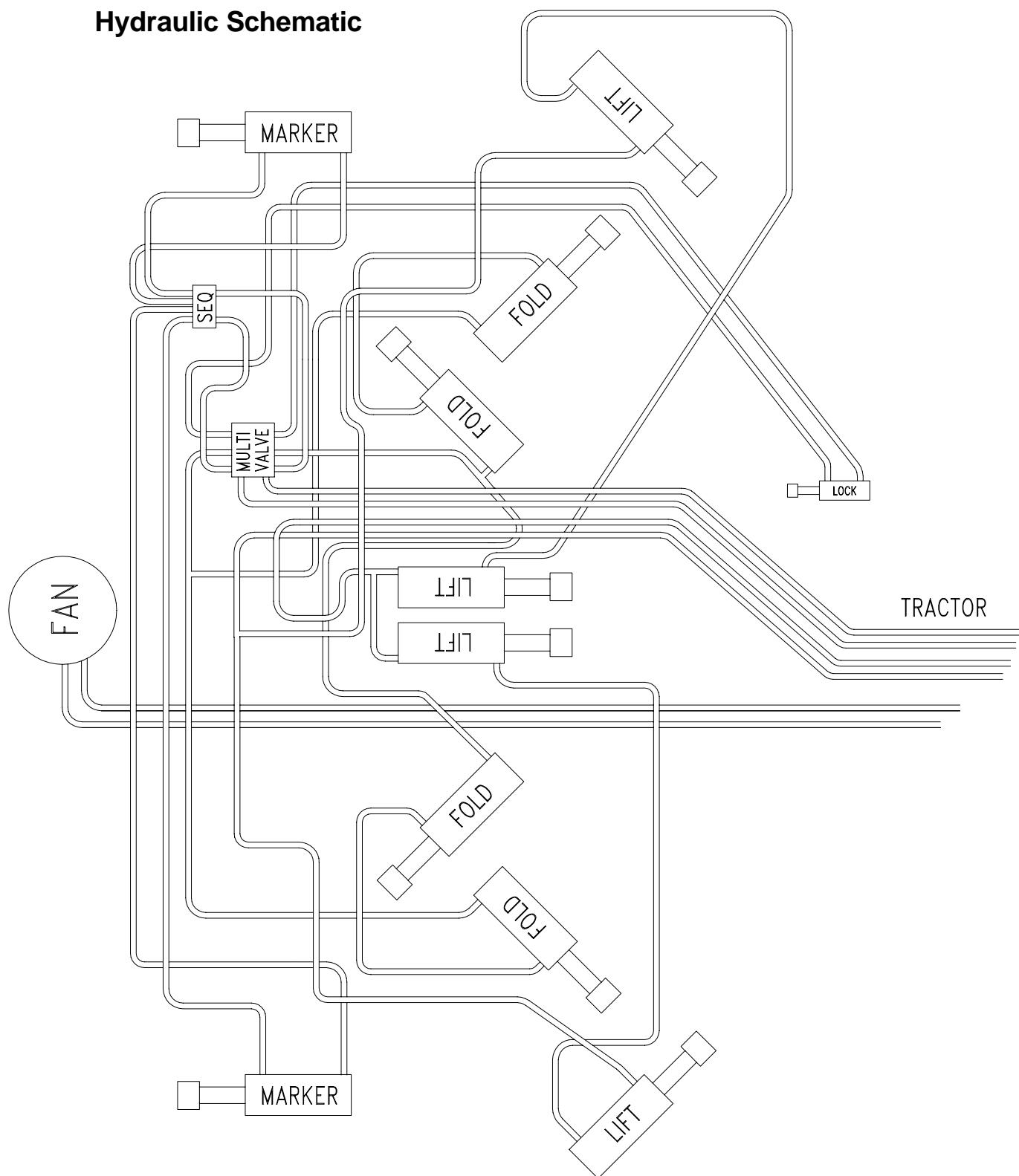

---

**Great Plains Manufacturing, Inc.**  
Corporate Office: P.O. Box 5060  
Salina, Kansas 67402-5060 USA

---